



AZL21...



AZL23...

Display and Operating Units

AZL2...

The AZL2 display and operating units are designed for use with the LFS1 flame safeguard, the LME39 / LMO39 burner controls and the LMV2 and LMV3 burner management systems, either directly on the burner or in control panels installed close to the burner.

- The units are used for the display, operation and parameterization of specific safety- and non-safety-related burner functions
- Key plant data and fault codes can be queried and displayed
- Communication between AZL2 and the flame safeguard / burner control takes place via the BCI interface

The AZL2... and this Data Sheet are intended for use by OEMs which integrate the display and operating units in their products!

Use / features

Listed below is the full scope of functions of the AZL2...units.

The specific functions and operating philosophy must be determined based on the type of flame safeguard / burner control used.

- Housing of modern design made of recyclable plastic
- Flame-resistant housing material
- Display of operating states, program phases and fault codes
- Setting of parameters and ratio curves
- 8-digit LCD with bars
- LCD with backlit display (support dependent on respective flame safeguard / burner control)
- 5 multifunction buttons with reset facility
- BCI interface
- Prepared for extra fault indication via LED (on request)
- Backup function / restore function with specific types of flame safeguards / burner controls (on request)

AZL21...

- Housing designed for wall mounting
- Degree of protection IP40 when mounted

AZL23...

- Housing designed for flush-panel mounting
- Degree of protection IP54 when mounted

Supplementary documentation

Product type	Type of documentation	Documentation number
LFS1...	User documentation	A7782
	Data Sheet	N7782
LME39...	Data Sheet	N7106
	Basic Documentation	P7106
LME7...	Data Sheet	N7105
	Basic Documentation	P7105
LMO39...	Data Sheet	N7154
	Basic Documentation	P7154
LMV26...	Data Sheet	N7547
	Basic Documentation	P7547
LMV27.100...	Data Sheet	N7541
	Basic Documentation	P7541
LMV36...	Data Sheet	N7544
	Basic Documentation	P7544
LMV37.4...	Data Sheet	N7546
	Basic Documentation	P7546

Warning notes



For additional safety notes, refer to the documentation for the flame safeguard, the burner controls and the burner management systems!

To avoid injury to persons, damage to property or the environment, the following warning notes must be observed!

- The units may only be used in building services plant and only in compliance with the applications described in this Data Sheet
- When employing the products, all requirements specified in the following sections must be observed
- Local safety regulations (installation, etc.) must be complied with
- The units must not be opened. If violated, warranty by Siemens becomes void



Caution

Do not open, interfere with or modify the units!

- All activities (mounting, installation and service work, shut down etc.) must be performed by qualified staff
- Before making any wiring changes in the connection area, completely isolate the plant from mains supply (all-polar disconnection). Ensure that the plant cannot be inadvertently switched on again and that it is indeed dead. If not observed, there is a risk of electric shock hazard
- Ensure protection against electric shock hazard by providing adequate protection for the connection terminals. If this is not observed, there is a risk of electric shock
- Each time work has been carried out (mounting, installation, service work, shut down, etc.), check to ensure that wiring and catch mechanism of the BCI interface (jack RJ11) into the AZL2... housing and parameterization is in an orderly state. If this is not observed, there is a risk of loss of safety functions and a risk of electric shock
- Fall or shock can adversely affect the safety functions. Such units must not be put into operation, even if they do not exhibit any damage. If this is not observed, there is a risk of loss of safety functions and a risk of electric shock

Siemens will not assume liability for damage resulting from unauthorized interference!

Electromagnetic emissions must be checked on an application-specific basis!

Qualified staff

Only **qualified staff** are allowed to install and operate the units. Qualified staff in the context of the safety-related notes contained in this Data Sheet are persons who are authorized to commission, ground and tag devices, systems and electrical circuits in compliance with established safety practices and standards.

Correct use

Note the following:

The unit may only be used for the applications described in the technical documentation and only in connection with flame safeguards / burner controls supplied by Siemens.

The products can only function correctly and safely if shipped, stored, set up and installed correctly, and operated and maintained as specified.

Mounting notes

- Ensure that the relevant national safety regulations are complied with
- Observe that the screw-on area must be flat.
- Always use the AZL2... in dry and clean environments

Flush-panel mounting AZL23...

Step 1

Place the AZL2... into the cutout as shown (without applying any force).

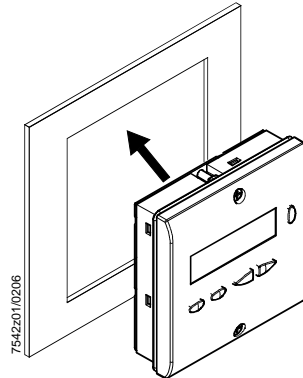

Step 2

Secure the AZL2... with the 2 Phillips-head screws provided (without applying any force).



Note:
If the AZL2... does not fit in the cutout, check the dimensions of cutout and housing.

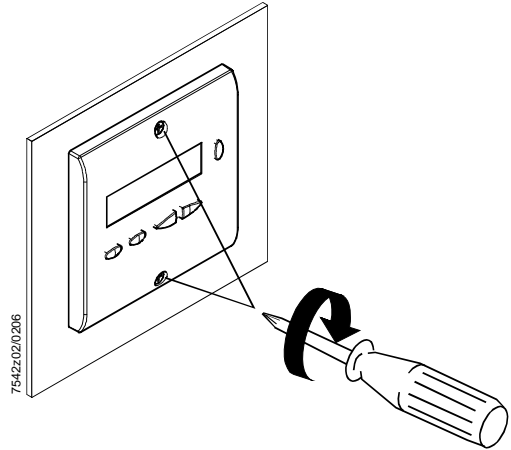

- Observe a tightening torque of 0.4 Nm for the screws to ensure the requirements of IP54 are satisfied

Dimensions of cutout AZL23...

The units' mounting dimensions are 92 x 92 mm. Due to the front's dimensions, the resulting spacing is 96 mm. Thanks to the mounting mechanism, the units can be fitted in panel fronts of different material thicknesses (1...3 mm).

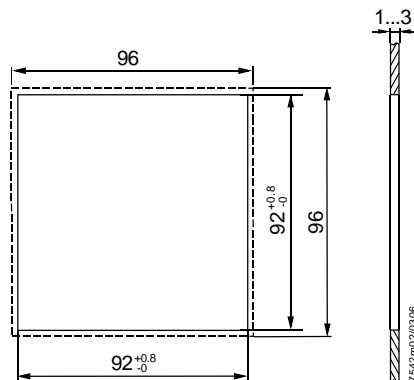

AZL21...









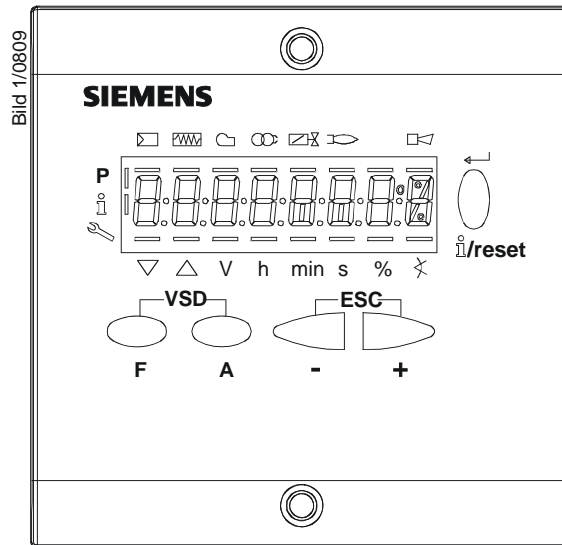









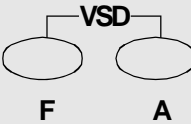



- Ensure that the mounting surface is completely flat
- Use screws M5 with washers (e.g. similar to 10-UNF)

Operating / display philosophy

For the operating and display philosophy, refer to the User Manuals for the respective flame safeguard / burner control.

Function and operation of the different types of AZL2... are identical.

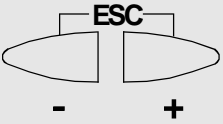

Button	Function
 F	F button - For driving the fuel actuator to another position (keep  depressed and adjust the value by pressing  or )
 A	A button - For driving the air actuator to another position (keep  depressed and adjust the value pressing  or )
 F A	A-button and F-button: Parameterization function - For changing to parameter setting mode P (press simultaneously  and  plus  or ) - For readjusting the speed of the VSD operation (press  and  with  or  simultaneously)
 i/reset	Info and Enter button - For navigating in info and service mode * Incrementing the selection (flashing symbol) (press button for <1 s) * Going one menu level down (press button for 1...3 s) * Going one menu level up (press button for 3...8 s) * Changing to operating mode (press button for >8 s) - Enter in parameter setting mode - Reset in the event of fault - One menu level down
 -	- button - For decreasing the value - For navigating during curve adjustments in info and service mode
 +	+ button - For increasing the value - For navigating during curve adjustments in info and service mode
 - +	- and + buttons: Escape function (press  and  simultaneously) - No adoption of value - One menu level up

Meaning of symbols on the display

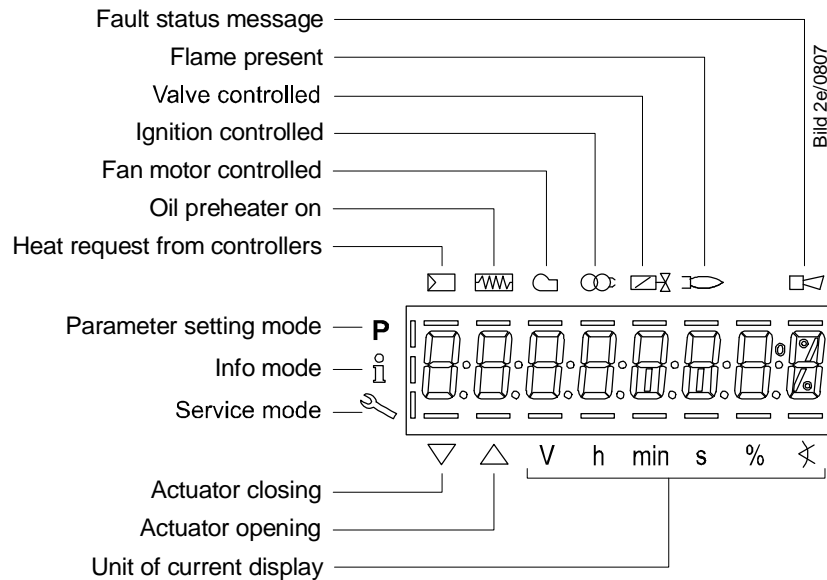

Installation notes

- The plugs of the connecting cables for the AZL2... may only be removed or replaced when the plant is disconnected from power (all-polar disconnection) since there is no safe separation between BCI interface and mains voltage
 - Signal cable AGV50 from the safeguard / burner control to AZL2
 Since there is no safe separation between the BCI and the mains voltage, the signal cable AGV50 from the flame safeguard / burner control to the AZL2 must conform to the defined specifications (refer to Technical data).
 The specification of the signal cable AGV50... required for this application is given inside the burner cover. When using signal cables that do not comply with the specification, there is a risk that requirements will not be satisfied
 - Do not lay the signal cable AGV50 from the flame safeguard / burner control to the AZL2 together with other cables
 - The signal cable AGV50... and the AZL2... must be shipped and stored such that dust and water cannot have any adverse effect
 - To ensure protection against electric shock hazard, make certain that – prior to switching on mains voltage – the cable is correctly connected to the AZL2...
 - The AZL2... must be used in a dry and clean environment
 - Prior to installation, the units must be disconnected from power
 - Wiring must satisfy the requirements of safety class II
 - Static charges must be avoided since they can damage the electronic components of the units when touched
- Recommendation:** Use ESD equipment!



Danger

- DIN EN 60 335 and DIN EN 60 730-2-5 must be complied with
- The electrical wiring inside the boiler must conform to national and local regulations
- Degree of protection IP40 / IP54 as per DIN EN 60529 for flame safeguards / burner controls must be ensured by the burner or boiler manufacturer through correct installation of the AZL2. If this is not observed, there is a risk of loss of safety functions and a risk of electric shock

Commissioning notes

Prerequisites The burner or boiler manufacturer assumes responsibility for the correct parameterization of the flame safeguards / burner controls in compliance with the relevant standards and directives.

Standards and certificates



Note!
Only in connection with burner controls!



EAC Conformity mark (Eurasian Conformity mark)



ISO 9001:2008
ISO 14001:2004
OHSAS 18001:2007





China RoHS
Hazardous substances table:
<http://www.siemens.com/download?A6V10883536>

Disposal notes



The units contain electrical and electronic components and must not be disposed of together with domestic waste. Local and currently valid legislation must be observed.

Type summary

Article no.	Type		
BPZ:AZL21.00A9	AZL21.00A9	Display and operating unit for wall mounting	
BPZ:AZL23.00A9	AZL23.00A9	Display and operating unit for flush-panel mounting	

Technical data

General unit data	Operating voltage	DC 5 V	
	Power consumption	<50 mW (typically)	
	Degree of protection		
	- AZL21...	IP40 to IEC 529	
	- AZL23...		
	- Rear	IP40 to IEC 529	
	- Front	IP54 to IEC 529 when mounted	
	Safety class	II to DIN EN 60730-1	
	Housing		
	- Material	PC and PC / ABS	
	- Color	RAL 7035 (light-grey)	
	Flame protection class		
	- Transparent housing parts	To UL94 V2 (PC)	
	- Colored housing parts	To UL94 V0 (PC / ABS)	
	Signal cable AGV50... display → BCI	Signal cable	Color white Unshielded Conductor 4 x 0.141 mm ² With connector RJ11
Cable length			
- AGV50.100		1 m	
- AGV50.330		3 m	
Location		Under the burner hood (arrangements for SKII EN 60730-1 additional required)	
For permissible cable length, refer to the Data Sheet of the relevant type of flame safeguard / burner control.			
Inputs / outputs		BCI interface with RJ11 female	For Siemens flame safeguards / burner controls
Environmental conditions		Storage	DIN EN 60721-3-1
		Climatic conditions	Class 1K3
		Mechanical conditions	Class 1M2
		Temperature range	-20...+60 °C
		Humidity	<95 % r.h.
		Transport	DIN EN 60721-3-2
		Climatic conditions	Class 2K3
	Mechanical conditions	Class 2M2	
	Temperature range	-30...+60 °C	
	Humidity	<95 % r.h.	
	Operation	DIN EN 60721-3-3	
	Climatic conditions	Class 3K3	
	Mechanical conditions	Class 3M3	
	Temperature range	-20...+60 °C	
	Humidity	<95 % r.h.	
Installation altitude	Max. 2,000 m above sea level		



Warning!

Condensation, formation of ice and ingress of water are not permitted!

If this is not observed, there is a risk of loss of safety functions and a risk of electric shock

Connection diagram

Example: Basic diagram AZL2... with LMV27.1...

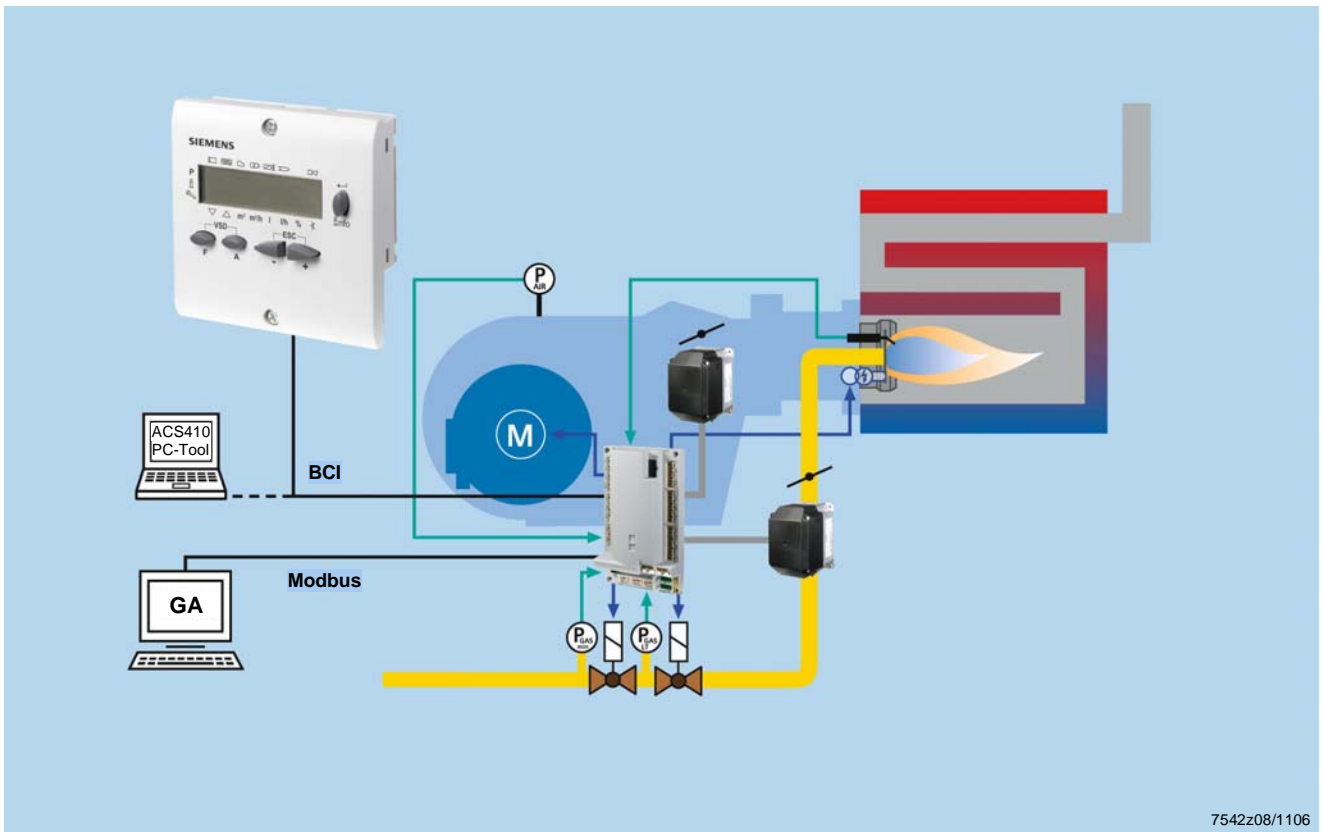

Connection of AZL21...
to LFS1...

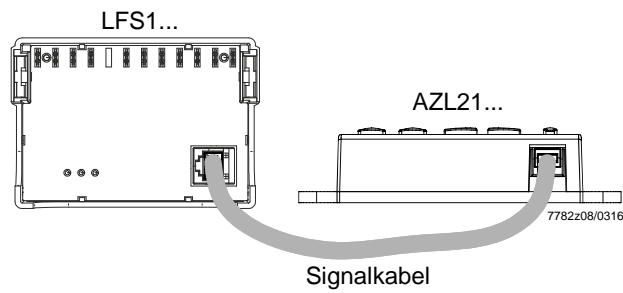

Connection of AZL21...
to LME39... / LMO39...

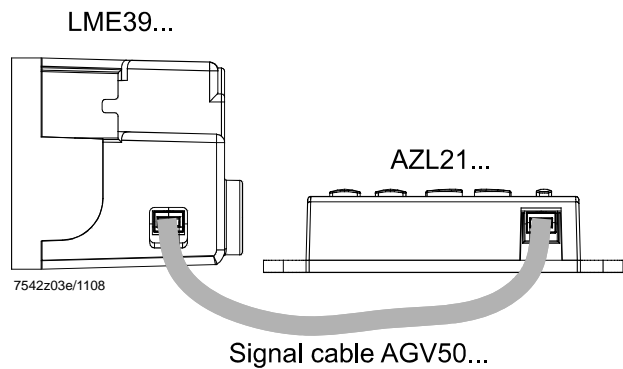

Connection diagram (continued)

Connection of AZL23...
to LMV2... / LMV3...

LMV2... / LMV3...

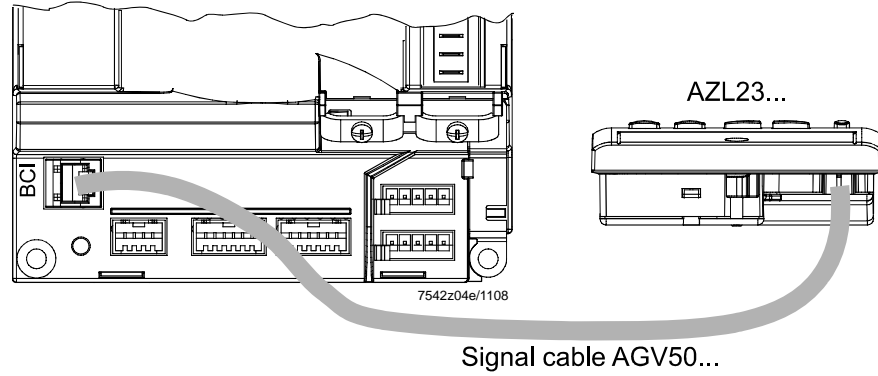

Dimensions

Dimensions in mm

AZL21...

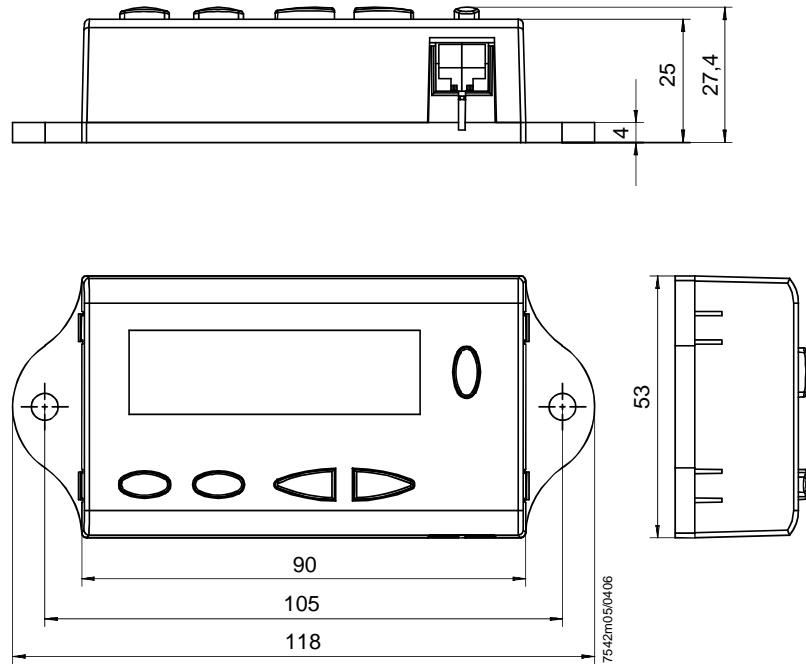

AZL23...

